

COND SYSTEM

Outdoor wall-mounted condensing boilers combined with indoor unit heaters



PLAY EXTRA SV 32
Heating only boiler for external installation with remote control as standard



Aeroclima STYLE 10 - 15 Air heater with advanced control B-TOUCH or 3-speed basic control or electronic thermostat



MULTIDEA EVO EXTRA S.45 - S.70 - S.95 - S.110 - S.150
Heating only boiler for external installation with remote control as standard



CLASS 6



HIGH EFFICIENCY
108% CERTIFIED



ROTATING SHELF AS STANDARD



GAS CONDENSATION SYSTEM



HEATING

Technical and construction characteristics

COND SYSTEM:

It is a product consisting of a latest generation outdoor condensing boiler and one or more indoor hydronic air heaters. This product is particularly suitable for heating laboratories, warehouses and environments where work is carried out with flammable materials (wood, paper, paints, solvents, etc.), avoiding V.V.F. practices. The proposed boiler models are the following:

Boiler PLAY EXTRA SV 32:

It is a 32 kW wall-mounted gas condensing boiler with IPX5D protection rating, the specific flue kit (consisting of vertical start, 90° bend and exhaust terminal) and the remote control are supplied as standard. The boiler is equipped with a stainless steel and aluminum primary exchanger, total premix burner with high modulation, and modulating circulator, 9 liter expansion tank and automatic by-pass.

MULTIDEA EVO EXTRA S.45 - S.70 - S.95 - S.110 - S.150 boiler: They are high-power wall-mounted gas condensing boilers with IPX4D protection rating and I.N.A.I.L. kit. included.

The boilers have the following characteristics: high head available on the water side, high modulation range, efficiency at 30% of the load greater than 108%, seasonal energy efficiency of Class A space heating, yields compliant with Reg. 811 and 813/2013 ErP, integrated modulating primary circulator, tilting control panel and extractable electronic card compartment to facilitate maintenance and electrical connection operations.

Aeroclima STYLE unit heaters:

They essentially consist of a heat exchange unit between the fluid circulating inside the exchanger and the air flow exerted by the ventilation unit.

The ambient air is sucked in by the fans and pushed through the heat exchanger, which releases heat from the air itself in winter or removes heat in summer.

The treated air is introduced into the environment through the grille with horizontal fins, in extruded aluminium, which can be manually adjusted. The fan motors are single-phase with external rotor and it is possible to select 3 different operating speeds, chosen from 18 available via a special autotransformer.

The 4-row heat exchange battery is made with copper tubes and aluminum fins blocked by mechanical expansion of the tubes and also designed for air conditioning. The connections to the electrical panel, housed in a special waterproof box, are located on the left side of the appliance. Both types of connection, hydraulic and electrical, are also accessible from the side, after removing the shaped panels. The appliance is supplied as standard with a revolving wall fixing bracket.

Optional advanced self-adaptive B-TOUCH control:

















For the COND SYSTEM series, an extremely versatile and intuitive smart control platform is available to continuously modulate the ventilation speed of the Aereoclima STYLE terminal units in order to always guarantee maximum comfort and maximum energy efficiency.

Model	Thermal power kW*	Code	€
PLAY EXTRA SV 32 + n. 1 Aeroclima STYLE 15 (Mono)	33,5	30415002	5.100,00
PLAY EXTRA SV 32 + n. 2 Aeroclima STYLE 10 (Dual)	33,5	30405002	6.590,00
BLU POWER EXTRA 45 + n. 1 Aeroclima Style 15 (Mono)	46,4	30405013	9.950,00
MULTIDEA EVO EXTRA S.70 + n. 2 Aeroclima Style 15 (Dual)	74,5	30405014	14.390,00
MULTIDEA EVO EXTRA S.95 + n. 2 Aeroclima Style 15 (Dual)	101,2	30405018	16.000,00
MULTIDEA EVO EXTRA S. 95 + n. 3 Aeroclima Style 15 (Tripl)	101,2	30405019	18.700,00
MULTIDEA EVO EXTRA S. 110 + n. 4 Aeroclima Style 15 (Quadri)	118,7	30405017	23.100,00
MULTIDEA EVO EXTRA S. 150 + n. 5 Aeroclima Style 15 (Penta)	154,5	30405020	25.760,00

*Heating thermal power (50 - 30 °C)

COND SYSTEM

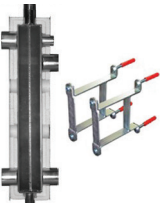









Outdoor wall-mounted condensing boilers combined with indoor unit heaters

Accessories PLAY EXTRA SV 32 e BLU POWER EXTRA		Code	€	
	External probe	30403109	26,00	
	Domestic hot water tank temperature probe (3 meters long)	mod. PLAY EXTRA SV 32 mod. MULTIDEA EVO EXTRA S	30403115 30403451	20,00 26,00
	Acid condensate neutralizer kit suitable for up to 350 thermal kW	30403453	306,00	
Accessories PLAY EXTRA SV 32				
	Antifreeze resistance kit	30403114	316,00	
	Adjustable semi-automatic self-cleaning magnetic dirt separator for vertical and horizontal installations with 3/4" connections	30403131	396,00	
	Hydraulic and gas fitting kit	30403135	38,00	
	Curve 90° Ø 80 M/F	30403013	8,00	
	Curve 45° Ø 80 M/F	30403012	8,00	
	Extension Ø 80 M/F = 1000 mm	30403011	10,00	
	Fume exhaust terminal Ø 80	30403122	18,00	
	3-way motorized diverter valve with 1" connections and spring return	16205308	204,00	
	DN20 2-way direct hydraulic module with inverter electronic circulator and flanged ball valve with T-handle on the system delivery, 20 mbar non-return valve, analogue thermometer on the system delivery and return.	35642001	484,00	
	Electrically welded and galvanized tubular distribution manifold, equipped with thermal insulation and galvanized sheet metal protection box for 2 DN20 direct modules	35652004	350,00	
	Pair of wall fixing brackets for DN20 manifolds	35652006	62,00	
	Insulated hydraulic separator for DN20 and DN25 collectors which allows the primary circuit to be hydraulically separated from the secondary circuit	35652510	380,00	
	Pair of brackets to support the hydraulic separator	35652511	76,00	







COND SYSTEM

Outdoor wall-mounted condensing boilers combined with indoor unit heaters

Accessories BLU POWER EXTRA 45 - 70 - 95 - 110 - 150

		Code	€
	Curve M/F 90° PP Ø 100	30403104	34,00
	Curve M/F 45° PP Ø 100	30403105	32,00
	Extension M/F in PP Ø 100 - 1000 mm	30403125	45,00
	Fume exhaust terminal Ø 100	30403222	28,00
	Transformation nozzle for propane gas	mod. 150 30403454	40,00
	Mixer for propane boiler transformation complete with nozzles	mod. 70 30403455	174,00
		mod. 95 30403456	174,00
		mod. 110 30403457	174,00
	3-way motorized diverter valve with 1" 1/4 connections and spring return	30403452	300,00
	Adjustable semi-automatic self-cleaning magnetic dirt separator for vertical and horizontal installations with 1" 1/4 connections	30403137	480,00
	DN25 2-way direct hydraulic module with inverter electronic circulator and flanged ball valve with T-handle on the system delivery, 20 mbar non-return valve, analogue thermometer on the system delivery and return.	35642501	624,00
	Distribution manifold in electro-welded and galvanized tubular, equipped of thermal insulation and box sheet metal protection galvanized for DN25 direct modules	mod. 2 forms DN25 35652501	390,00
		mod. 3 forms DN25 35652502	446,00
		mod. 4 forms DN25 35652503	650,00
		mod. 5 forms DN25 35652504	804,00
		Pair of wall fixing brackets for manifolds DN25	35652006
	Insulated hydraulic separator for DN20 and DN25 collectors which allows the primary circuit to be hydraulically separated from the secondary circuit	35652510	380,00
	Pair of brackets to support the hydraulic separator	35652511	76,00

Accessories Aeroclima STYLE 10 - 15

	Advanced command and control system composed of an electronic board on the air heater wired in the factory and a smart user interface with B-TOUCH backlit display equipped with an electronic room probe	36205231	420,00
	3-speed electronic room thermostat	50005230	82,00
	Mechanical consensus thermostat	36205214	36,00
	Basic 3-speed control	36205212	52,00
	Mechanical consensus thermostat	36205214	36,00
	3-way valve with ON/OFF actuator	36205404	180,00

COND SYSTEM

Outdoor wall-mounted condensing boilers combined with indoor unit heaters

Application example PLAY EXTRA SV 32 with 2 Aeroclima STYLE 10

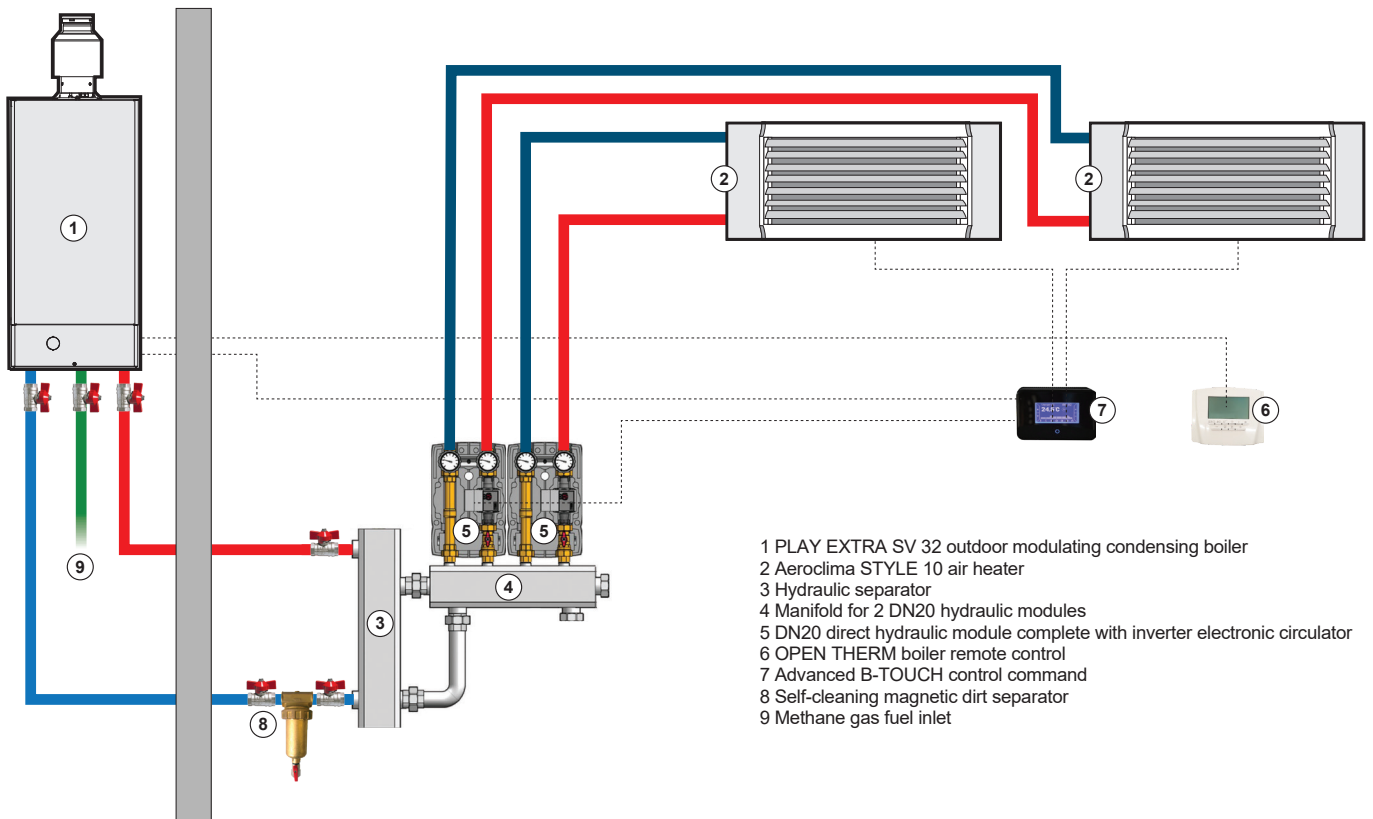

Application example MULTIDEA EVO EXTRA S.95 with 3 Aeroclima STYLE 15

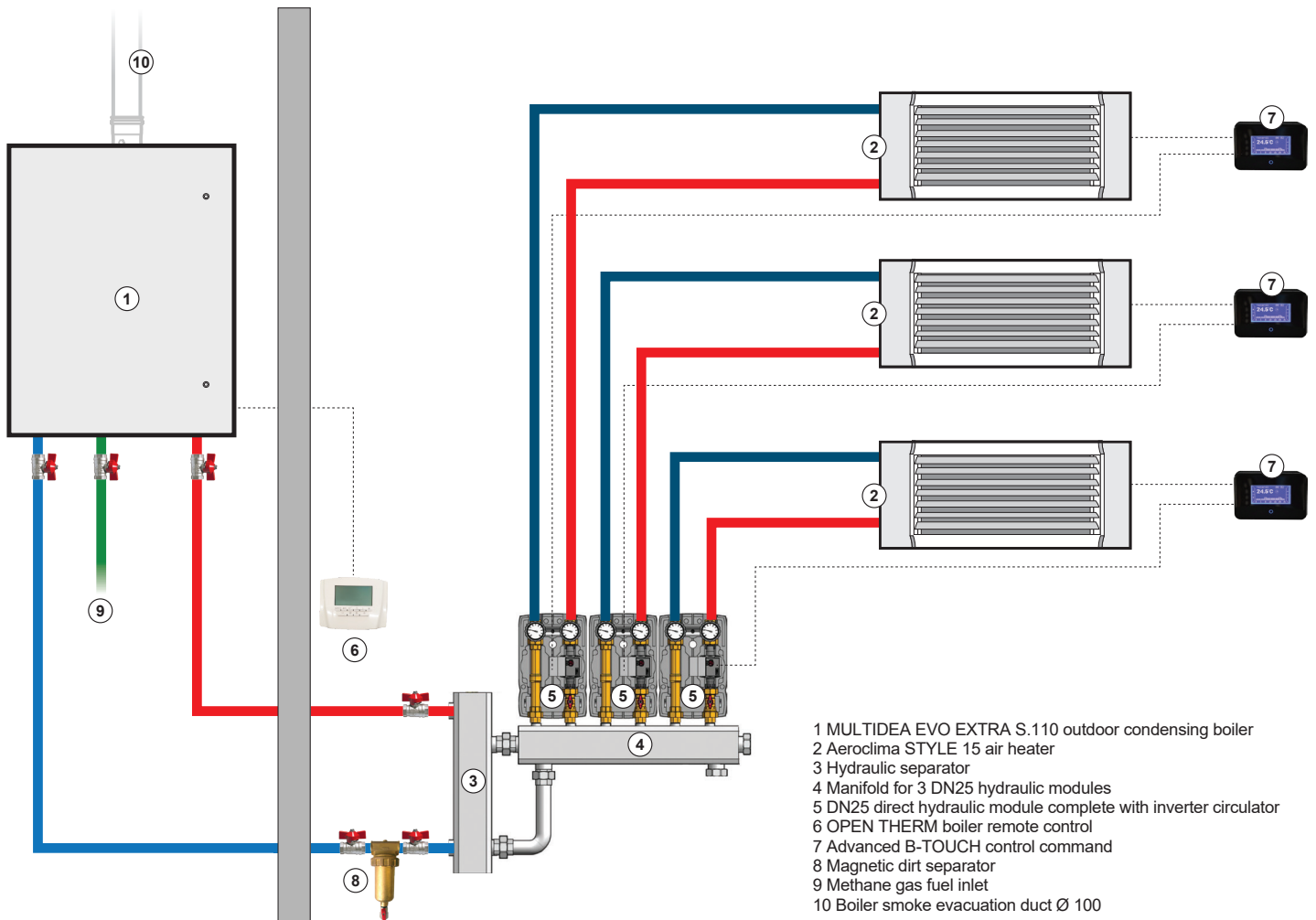

COND SYSTEM

Outdoor wall-mounted condensing boilers combined with indoor unit heaters

Application example MULTIDEA EVO EXTRA S.110 with 4 Aeroclima STYLE 15

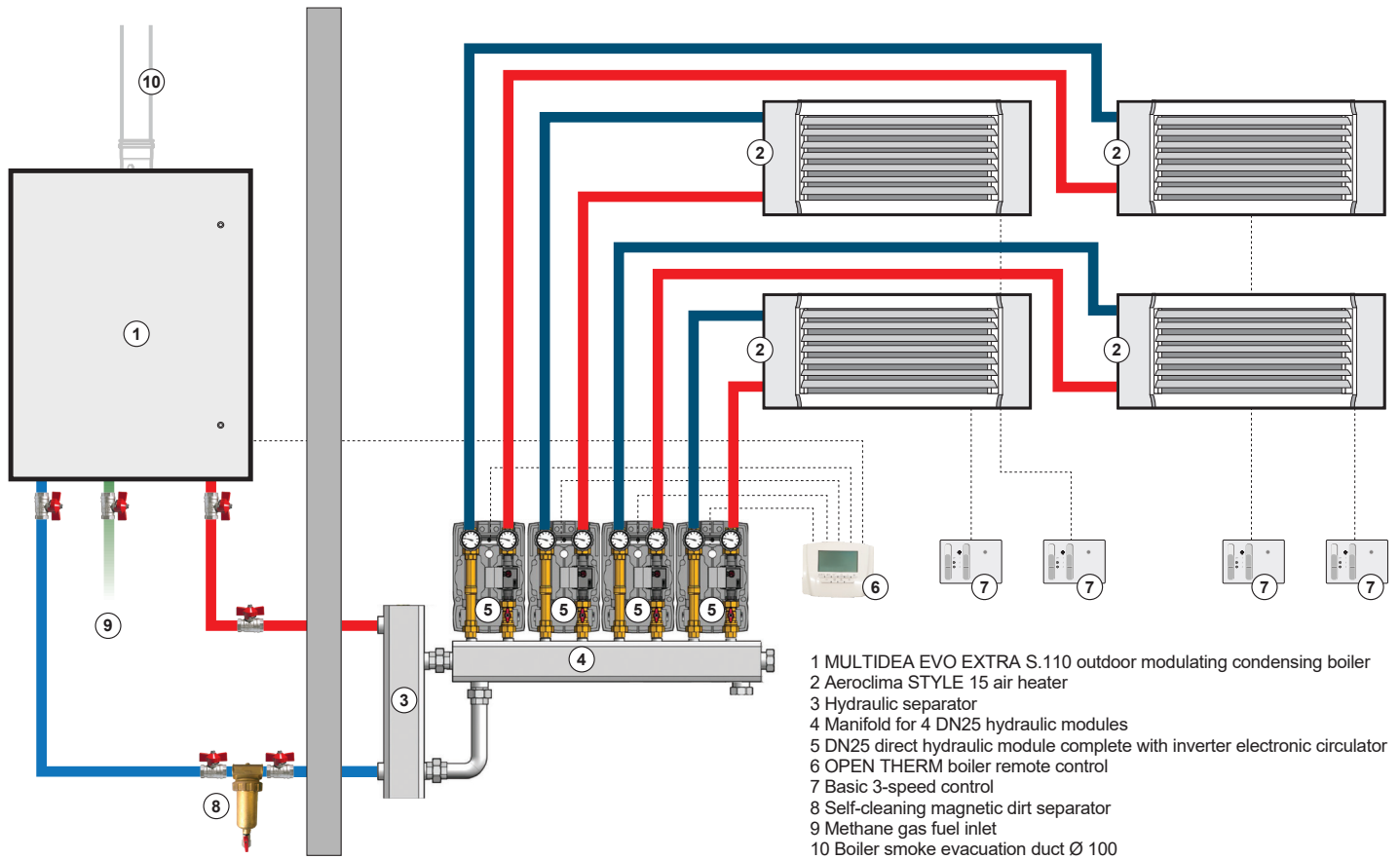

Application example MULTIDEA EVO EXTRA S.150 with 5 Aeroclima STYLE 15

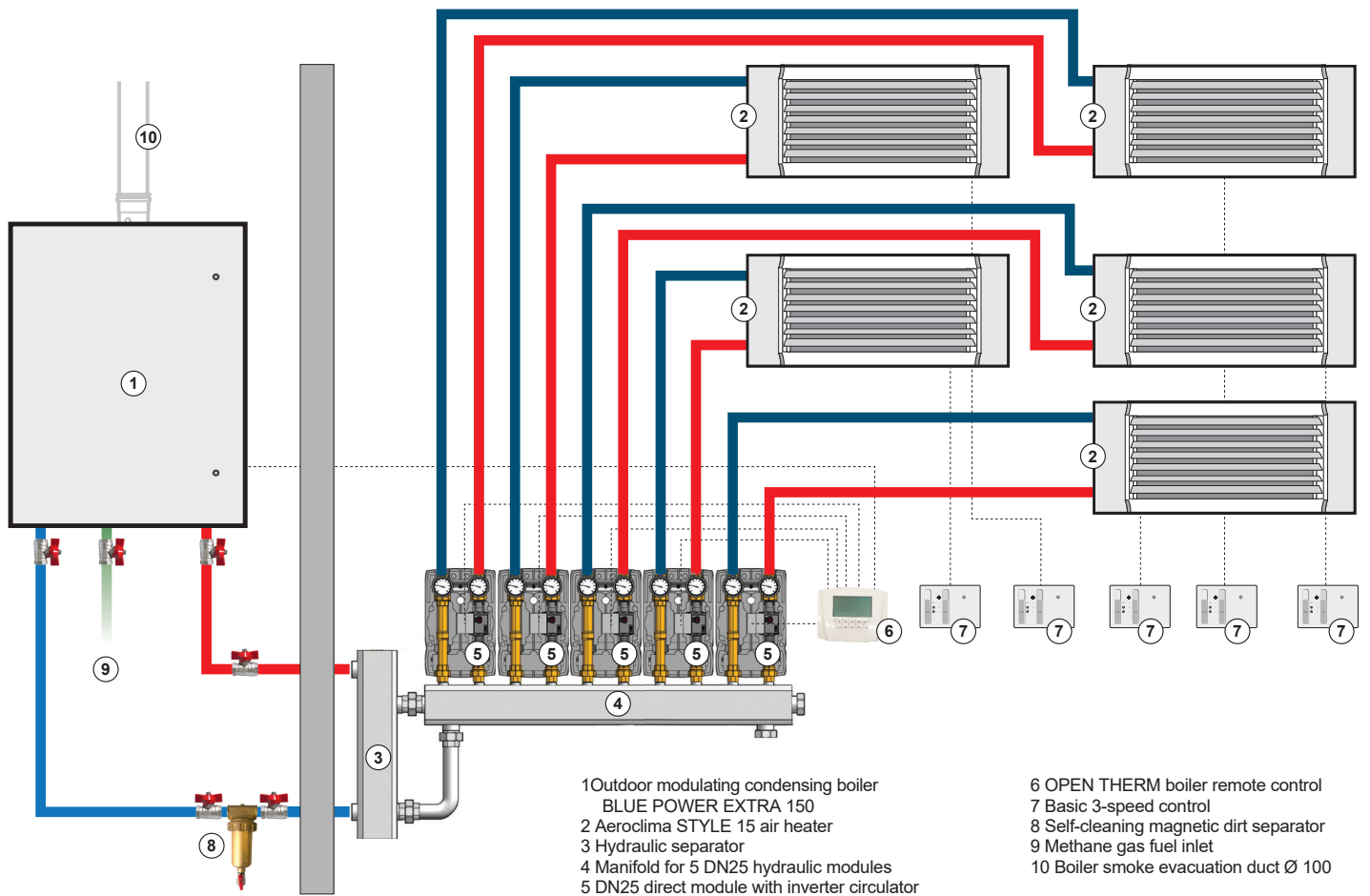

COND SYSTEM

Outdoor wall-mounted condensing boilers combined with indoor unit heaters

Boiler dimensions PLAY EXTRA SV 32

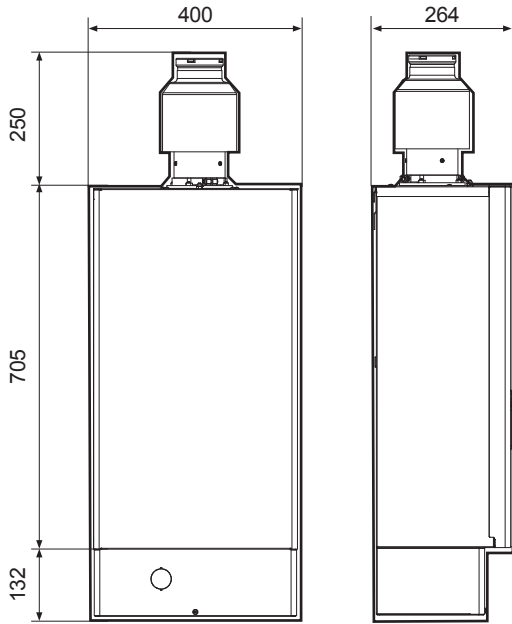

Values expressed in mm

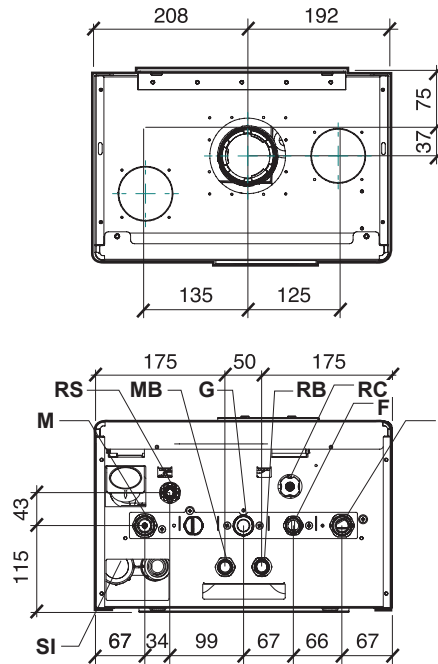

TOP VIEW

- F Cold water inlet (1/2")
- RB Secondary return from the boiler
- G Gas inlet (3/4")
- YES Siphon inspection cap
- M System delivery (3/4")
- MB Secondary flow for boiler
- R System return (3/4")
- RS Drain and waste tap
- RC safety valve
- Filling cock

BOTTOM VIEW

Outdoor boiler dimensions MULTIDEA EVO EXTRA S.45 - S.70 - S.95 - S.110 - S.150

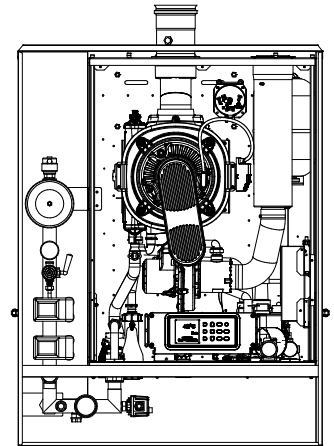
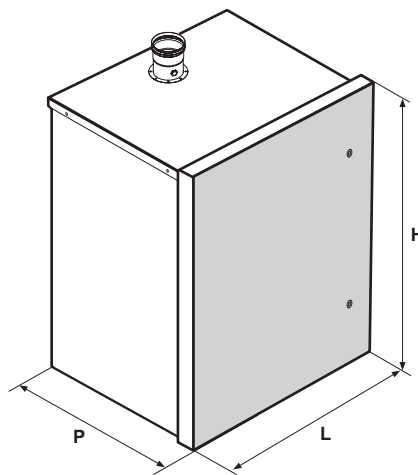
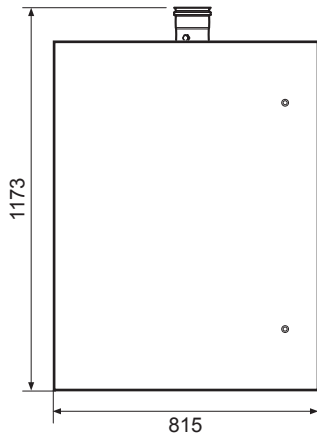
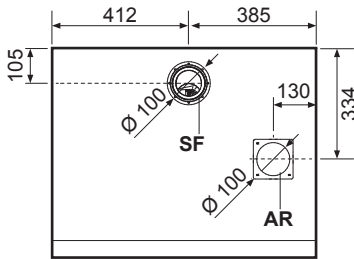

Model	45	70	95	110	150
L	815	815	815	815	815
H	1074	1074	1074	1074	1074
P	640	640	640	640	640
Weight	77 kg	86 kg	114 kg	123 kg	133 kg

Values expressed in mm

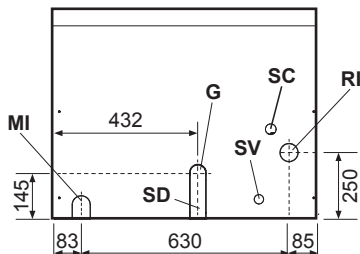

- MI System delivery (1" 1/4 M)
- RI System return (1" 1/4 M)
- SD Condensate siphon drain (25 mm)
- SV Safety valve drain
- SC Boiler drain
- SF Smoke exhaust (Ø 100)
- AR Air intake (Ø 100)
- G Methane gas/LPG inlet
(3/4" for mod. 45 - 70) (1" 1/4 for mod. 95 - 110 - 150)

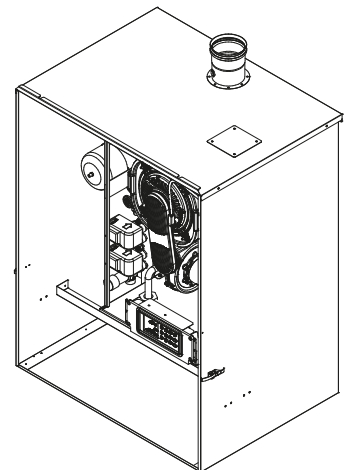

COND SYSTEM

Outdoor wall-mounted condensing boilers combined with indoor unit heaters

Air heater size Aeroclima STYLE 10

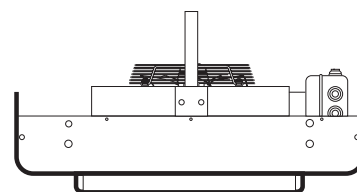
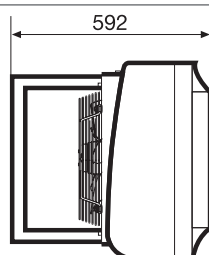
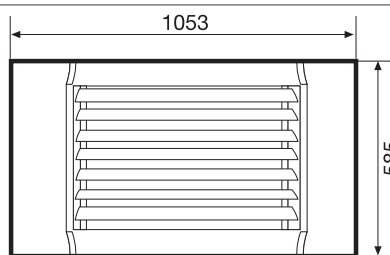

Values expressed in mm

Air heater size Aeroclima STYLE 15

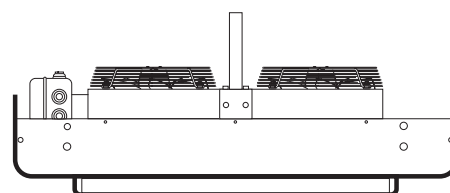
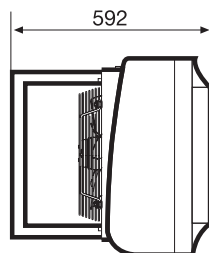
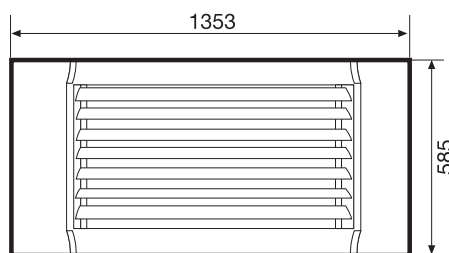

Values expressed in mm

Boiler technical data table BLU EXTRA S 32

DESCRIPTION	U.M.	PLAY EXTRA SV 32
Device category		I12H3P
Heating heat output min.	kW	3,4
Heating heat output max.	kW	32,0
Heating thermal power min. (80-60 °C)	kW	3,3
Heating thermal power max. (80-60 °C)	kW	30,8
Heating thermal power min. (50-30 °C)	kW	3,5
Heating thermal power max. (50-30 °C)	kW	33,5
Seasonal space heating efficiency class		A
Water heating energy efficiency class		A
Supply pressure (Methane Gas function)	mbar	20
Supply pressure (LPG function)	mbar	30 / 37
Diaphragm diameter	mm	6,3
C02 value of fumes min. (Methane Gas function)		8,4%
C02 value of fumes max. (Methane Gas function)		10,6%
C02 value of fumes min. (LPG function)		10,5%
C02 value of fumes max. (LPG function)		10,6%
Min. pressure of the heating circuit	bar	0,5
Max. pressure of the heating circuit	bar	3
Min. pressure of the healthcare circuit	bar	0,5
Max. pressure of the healthcare circuit	bar	6
Specific domestic water flow rate (Δt 30K)	l/min	14
Power supply		230V/1/50Hz
Fuse on the power supply	A	3,15
Max power absorbed	W	102
Methane gas consumption at max flow rate in heating*	m ³ /h	3,37
LPG consumption at max flow rate in heating*	m ³ /h	0,97
G20 heating fan speed max. / min. (x 100)	rpm	52 / 11
Number of DHW G20 fan revolutions max. / min. (x 100)	rpm	62,5
Number of LPG heating fan revolutions max. / min. (x 100)	rpm	53 / 9
Number of sanitary LPG fan revolutions max. (x 100)	rpm	59,5
Number of fan revolutions G20 ignition (x 100)	rpm	35
Number of fan revolutions G20 ignition (x 100)	rpm	32
Max. temperature of heating operation	°C	85
Max. temperature of operation in healthcare	°C	60
Total capacity of expansion tank	l	9
Degree of protection		IP X5D
Net weight	Kg	32,4

COND SYSTEM

Outdoor wall-mounted condensing boilers combined with indoor unit heaters

Boiler combustion data table PLAY EXTRA SV 32

DESCRIPTION	U.M.	Pmax	Pmin
Shell leaks when the burner is working		1,3%	2,5%
Leaks with burner off		0,2%	1,8%
Chimney leaks when the burner is working		2,4%	1,8%
Mass flow rate of fumes	g/s	15,0	1,9
Smoke temperature	°C	74,5	63,0
Thermal efficiency useful for power max (60/80 °C)		97,1%	
Thermal efficiency useful for power max (30/50 °C)		109,8%	
Thermal efficiency useful for power min. (60/80 °C)		95,7%	
Thermal efficiency useful for power min. (30/50 °C)		103,5%	
Useful thermal efficiency at 30% of the load		110,7%	
Emission class NOX		6	

Boiler technical data table MULTIDEA EVO EXTRA S

DESCRIPTION	U.M.	45	70	95	110	150
Device category		I12H3P				
Heating heat flow (max/min)	kW	45,0 / 5,0	69,9 / 7,7	95,0 / 10,5	115,0 / 12,0	150,0 / 20,0
Thermal power with ΔT 80°/60° (max/min)	kW	43,8 / 4,8	68,0 / 7,5	92,9 / 10,2	112,0 / 11,8	146,1 / 19,2
Thermal power with ΔT 50°/30° (max/min)	kW	46,4 / 5,3	74,5 / 8,1	101,2 / 11,2	118,7 / 12,5	154,5 / 20,7
Useful return to PCI 100% (50/30 °C)		103,1%	106,6%	106,5%	103,2%	103,0%
Heating energy efficiency class		A				
Minimum pressure of the heating circuit	bar	0,5				
Safety valve opening pressure	bar	4,0				5,4
Maximum operating pressure	bar	4,5				6,0
Power supply		230V/1/50Hz				
Max power absorbed	W	300				540
Degree of protection for models		IPX4D				
Methane Gas Consumption at max flow rate*	m ³ /h	4,70	7,40	10,10	12,20	15,50
LPG consumption within reach max*	m ³ /h	1,90	2,70	3,90	4,50	6,00
Maximum operating temperature	°C	85,0				
ΔT maximum delivery-return	°C	35,0				
Total capacity of expansion vessel	l	5,00				
Boiler exchanger water content	l	2,7	3,5	6,8	8,4	10,1
Water flow rate $\Delta T= 20$ K nominal	m ³ /h	1,9	3,0	4,1	4,7	6,4
Residual pump head $\Delta T= 20$ K nominal	m H ₂ O	3,5	3,8	2,2	7,8	4,1
Fume exhaust connection	mm	100				
Shell losses with burner operating (Pmax/Pmin)		0,4/8,2 %	1,6/5,0 %	1,3/2,5 %		
Losses with burner off (Pmax/Pmin)		0,3/2,4 %	0,15/0,1 %	0,2/1,8 %		
Chimney losses with burner operating (Pmax/Pmin)		3,7/1,8 %	2,3/2,1 %	2,4/1,8 %		
Flue mass flow rate (Pmax/Pmin)	g/s	11,9 / 1,3	13,0 / 1,6	45,0 / 5,0	53,0 / 6,0	69,0 / 10,0
Smoke temperature	°C	80,0 / 55,0	68,0 / 65,0	80,0 / 55,0		
Max condensate production at Nominal Flow Rate	l/h	7,0	11,0	14,8	18,0	22,5
Thermal efficiency useful for power max (60/80°C)		97,3%	97,3%	97,8%	97,4%	97,4%
Thermal efficiency useful for power max (30/50°C)		103,1%	106,6%	106,5%	103,2%	109,8%
Thermal efficiency useful for power min. (60/80°C)		96,5%	97,2%	97,1%	98,2%	103,0%
Thermal efficiency useful for power min. (30/50°C)		102,1%	105,8%	106,9%	104,0%	103,4%
Useful thermal efficiency at 30% of the load		108,1%	108,4%	108,7%	108,3%	108,3%
Emission class NOx		6				
Empty weight	Kg	60	69	97	97	107

* Value referred to 15 °C - 1013 mbar

COND SYSTEM

Outdoor wall-mounted condensing boilers combined with indoor unit heaters

Technical data table AEROCLIMA STYLE 10 - 15

DESCRIPTION	U.M.		STYLE 10	STYLE 15
Inlet water heating power 70°C (ΔT 10°C) room air temperature 20 °C (1)	kW	max	24,60	42,50
		med	22,80	32,40
		min	19,60	26,70
Battery pressure drops within range min	kPa		3,2	4,3
Battery pressure drops within range max	kPa		12,3	14,1
Hydraulic circuit volume	l		4,0	6,0
Air side temperature difference	°C	max	33,5	31,5
		med	34,1	34,9
		min	35,9	37,2
Inlet water heating power 50°C (ΔT 5°C) room air temperature 20 °C (2)	kW	max	14,90	25,80
		med	13,80	19,60
		min	11,90	16,20
Battery pressure drops within range min	kPa		4,2	5,6
Battery pressure drops within range max	kPa		16,2	21,4
Air side temperature difference	°C	min	20,3	19,1
		med	20,7	21,1
		max	21,8	22,6
Air flow	m ³ /h	min	2180	4000
		med	1980	2750
		max	1620	2130
Auxiliary speeds (*)	n. / (m ³ /h)		15 / (450÷2200)	15 / (1080÷4600)
Number of fans	n.		1	2
Sound pressure (5 meters in free field with directionality factor =2)	dB(A)	max	49,5	49,6
		med	47,8	42,3
		min	45,6	37,7
Sound power	dB(A)	max	71,5	71,6
		med	69,8	64,3
		min	67,6	59,7
Auxiliary speed sound pressure min-max (**)	dB(A)		32,0÷56,3	34,8÷65,3
Power supply			230V/1/50Hz	
Launch	m	vel. max	20	22
		vel. min	14	15
Electrical power absorbed	W	max	115	220
		med	105	200
		min	85	180
Max current absorbed	A		0,63	1,20
Degree of protection for fan(s).			IP44	
Degree of protection of the device			IP24	

OPERATING LIMITS

Inlet water temperature min÷max	°C	3÷80
Pressure max	kPa	800
Max inlet air temperature	°C	45
Weight	Kg	44 59

(*) Selectable ventilation speeds in addition to the standard ones

(**) Sound pressure level at 1 meter, in free field with directionality factor 2, in the minimum and maximum value of the auxiliary speeds available.

(1) Value refers to the maximum flow rate of the air-water battery, 2116 l/h for the STYLE 10 and 3655 l/h for the STYLE 15, this flow rate value may vary depending on the type of boiler/air heater combination selected

(2) Value refers to the maximum flow rate of the air-water battery, 2563 l/h for the STYLE 10 and 4438 l/h for the STYLE 15, this flow rate value may vary depending on the type of boiler/air heater combination selected

COND SYSTEM

Outdoor wall-mounted condensing boilers combined with indoor unit heaters

Heating performance STYLE 10

Description	Heating yields ΔT 5 °C				Thermal power kW - D.B. air delivery temperature(°C)							
	20	15	10	5	20	15	10	5	20	15	10	5
Battery inlet air temp (°C)	20	15	10	5	20	15	10	5	20	15	10	5
Air flow (m ³ /h)	Speed max 2.180				Speed med 1.980				Speed min 1.620			
P. T. water flow 45 °C (kW)	12,1	15,0	18,0	26,1	11,2	13,9	16,7	19,5	9,7	12,0	14,4	16,6
Battery outlet air temp (°C)	36,5	35,4	34,5	28,7	36,8	35,8	35,0	34,2	37,7	37,0	36,4	35,8
P. T. water flow 50 °C (kW)	14,9	17,9	20,9	29,0	13,8	16,6	19,4	22,2	11,9	14,2	16,6	19,1
Battery outlet air temp (°C)	40,3	39,3	38,4	32,6	40,7	39,9	39,1	37,2	41,8	41,0	40,4	40,0
P. T. water flow 55 °C (kW)	17,8	20,7	23,8	26,9	16,4	19,2	22,0	24,9	14,1	16,5	18,9	21,4
Battery outlet air temp (°C)	44,2	43,2	42,4	41,6	44,6	43,8	43,0	42,3	45,8	45,2	44,6	44,2

Description	Heating yields ΔT 10 °C				Thermal power kW - D.B. air delivery temperature (°C)							
	20	15	10	5	20	15	10	5	20	15	10	5
Battery inlet air temp (°C)	20	15	10	5	20	15	10	5	20	15	10	5
Air flow (m ³ /h)	Speed max 2.180				Speed med 1.980				Speed min 1.620			
P. T. water flow 60 °C (kW)	18,9	21,9	25,0	28,2	17,5	20,3	23,2	26,1	15,1	17,5	20,0	22,5
Battery outlet air temp (°C)	45,7	44,8	44,0	43,4	46,2	45,4	44,7	44,1	47,6	47,0	46,6	46,2
P. T. water flow 70 °C (kW)	24,6	27,7	30,9	34,1	22,8	25,7	28,6	31,6	19,6	22,10	24,6	27,2
Battery outlet air temp (°C)	53,5	52,7	52,0	51,4	54,1	53,5	52,8	52,3	55,9	55,5	55,0	54,8
P. T. water flow 80 °C (kW)	30,4	33,5	36,7	40,0	28,1	31,0	34,0	37,0	24,2	26,6	29,2	31,9
Battery outlet air temp (°C)	61,4	60,6	59,9	59,4	62,1	61,4	60,9	60,4	64,3	63,7	63,5	63,4

Description	Heating yields ΔT 15 °C				Thermal power kW - D.B. air delivery temperature(°C)							
	20	15	10	5	20	15	10	5	20	15	10	5
Battery inlet air temp (°C)	20	15	10	5	20	15	10	5	20	15	10	5
Air flow (m ³ /h)	Speed max 2.180				Speed med 1.980				Speed min 1.620			
P. T. water flow 60 °C (kW)	17,2	20,2	23,2	26,4	15,9	18,7	21,6	24,5	13,8	16,2	18,7	21,2
Battery outlet air temp (°C)	43,4	42,5	41,6	40,9	43,8	42,0	41,4	40,7	45,3	44,7	44,2	43,8
P. T. water flow 70 °C (kW)	23,0	26,1	29,2	32,4	21,3	24,2	27,1	30,0	18,4	20,9	23,4	25,9
Battery outlet air temp (°C)	51,3	50,5	49,7	49,1	51,9	51,2	50,6	49,9	53,7	53,3	52,8	52,4
P. T. water flow 80 °C (kW)	28,8	31,9	35,1	38,4	26,7	29,6	32,5	35,6	23,0	25,5	28,0	30,7
Battery outlet air temp (°C)	59,2	58,4	57,7	57,2	60,0	59,3	58,7	58,3	62,1	61,7	61,3	61,2

Prestazioni in riscaldamento STYLE 15

Description	Heating yields ΔT 5 °C				Thermal power kW - D.B. air delivery temperature (°C)							
	20	15	10	5	20	15	10	5	20	15	10	5
Battery inlet air temp (°C)	20	15	10	5	20	15	10	5	20	15	10	5
Air flow (m ³ /h)	Speed max 4.000				Speed med 2.750				Speed min 2.130			
P. T. water flow 45 °C (kW)	20,9	26,0	31,1	36,4	16,0	19,8	23,7	27,7	13,2	16,3	19,5	22,8
Battery outlet air temp (°C)	35,5	34,3	33,1	32,0	37,3	36,4	35,6	34,9	38,4	37,7	37,1	36,7
P. T. water flow 50 °C (kW)	25,8	30,9	36,1	41,4	19,6	23,5	27,5	31,5	16,2	19,3	22,6	25,9
Battery outlet air temp (°C)	39,1	37,9	36,8	35,7	41,1	40,3	39,7	39,0	42,6	41,9	41,5	41,1
P. T. water flow 55 °C (kW)	30,7	35,8	41,1	46,5	23,3	27,2	31,2	35,3	19,2	22,4	25,7	29,0
Battery outlet air temp (°C)	42,8	41,5	40,5	39,5	45,1	44,3	43,6	43,1	46,7	46,2	45,8	45,4

Description	Heating yields ΔT 10 °C				Thermal power kW - D.B. air delivery temperature (°C)							
	20	15	10	5	20	15	10	5	20	15	10	5
Battery inlet air temp (°C)	20	15	10	5	20	15	10	5	20	15	10	5
Air flow (m ³ /h)	Speed max 4.000				Speed med 2.750				Speed min 2.130			
P. T. water flow 60 °C (kW)	32,6	37,8	43,1	48,5	25,0	28,9	33,0	37,1	20,6	23,9	27,2	30,6
Battery outlet air temp (°C)	44,2	43,0	42,0	41,0	47,0	46,2	45,6	45,0	48,7	48,3	47,9	47,6
P. T. water flow 70 °C (kW)	42,5	47,8	53,2	58,8	32,4	36,5	40,6	44,8	26,7	30,0	33,4	36,9
Battery outlet air temp (°C)	51,5	50,4	49,4	48,6	54,9	54,4	53,8	52,3	57,2	56,8	56,5	56,4
P. T. water flow 80 °C (kW)	52,4	57,8	63,4	69,0	39,9	44,0	48,2	52,6	32,8	36,2	39,7	43,2
Battery outlet air temp (°C)	58,8	57,9	57,0	56,2	63,0	62,4	62,0	61,7	65,7	65,4	65,3	65,1

Description	Heating yields ΔT 15 °C				Thermal power kW - D.B. air delivery temperature (°C)							
	20	15	10	5	20	15	10	5	20	15	10	5
Battery inlet air temp (°C)	20	15	10	5	20	15	10	5	20	15	10	5
Air flow (m ³ /h)	Speed max 4.000				Speed med 2.750				Speed min 2.130			
P. T. water flow 60 °C (kW)	29,5	34,7	40,0	45,4	22,8	26,8	30,8	34,9	18,9	22,2	25,5	28,9
Battery outlet air temp (°C)	41,9	40,7	39,7	38,7	44,6	43,9	43,2	42,6	46,3	45,9	45,5	45,2
P. T. water flow 70 °C (kW)	39,6	44,9	50,3	55,7	30,4	34,4	38,5	42,7	25,1	28,5	31,8	35,3
Battery outlet air temp (°C)	49,4	48,3	47,3	46,3	52,8	52,1	51,5	51,0	54,9	54,7	54,3	54,1
P. T. water flow 80 °C (kW)	49,6	55,0	60,5	66,1	38,0	42,1	46,3	50,6	31,3	34,7	38,2	41,7
Battery outlet air temp (°C)	56,8	55,8	54,9	54,0	61,0	60,4	59,9	59,6	63,6	63,3	63,2	63,1